

DX0.6 User Guide

Loudspeaker management
system



Copyright © 2024 Martin Audio Limited

Publication date 2024-09-20

Important safety instructions

- Please read these instructions and keep them for future reference.
- Heed all warnings and follow all instructions.
- Keep this unit away from rain or moisture.
- Keep this unit away from heat sources.
- Keep this unit away from candles and flames.
- Don't block the ventilation openings.
- Install in accordance with Martin Audio instructions.
- Don't remove the protective earth from the power cable plug. This unit must be earthed.
- Protect the power cable from being walked on or damaged, particularly near the plugs.
- Unplug this unit during lightning storms or when unused for a long period of time.
- Don't open this unit. There is a risk of electric shock and there are no user-serviceable parts.
- If servicing is required, contact qualified service personnel.
- At the end of this unit's life, please use a recycling centre.

Table of Contents

Introduction	5
Features	5
Getting started	6
Desktop app	6
Connecting your processor and computer	6
Setting up using the front panel	7
Controlling front panel access	7
Connecting your system	7
Remember	7
Front panel	8
Back panel	9
Utility menu	10
To use the utility menu	10
Utility menu choices	10
System utilities	11
Input source	11
Signal generator	11
Link input	12
Link output	12
Linked channel mode	12
Recall mode	13
Set factory value	13
Prevent output clip	13
Output vu-meter	14
Firmware version	14
Program utilities	16
Recall a program	16
Save a program	16
Network utilities	17
RS-485 ID	17
Device name	17
IP address	17
Subnet mask	18
Gateway	18
LAN mode	18
Security utilities	20
To log in as Admin or Expert	20
To log out	20
Input channels	21
To edit the input channels	21
Input channel menu	21
Input name	21
Input noise gate	22
Input gain	22
Input polarity	22
Input delay	23
Enable input EQ	23
Ten band input EQ	23
Output channels	25

To edit the output channels	25
Output channel menu	25
Output name	25
Resetting a channel to factory defaults	26
Output source	26
Output gain	26
Output polarity	27
Output delay	27
Peak limiter	27
Program limiter	27
Output FIR enable	28
High pass filter	28
Low pass filter	28
Enable output EQ	29
Eight band output EQ	29
Example systems	30
BlacklineX12 and X118 subs	30
O-Line arrays and SX112 subs	30
Two pairs of LE200 monitors	31
CDD12, CDD6 and SX212 subs	31
THV and SX118 subs	32
BlacklineX12 and SXC115 subs	32
Troubleshooting	34
No power	34
Noise or hum	34
No sound	34
One side is louder than the other	34
Bad sound	34
Can't change settings	34
Technical specifications	36

Introduction

The DX0.6 is a digital audio processor with an extremely low noise floor, high dynamic range and powerful internal DSP. It delivers excellent performance in meeting rooms, small theaters and clubs.

The DX0.6 uses powerful custom Digital Signal Processing and an original DSP algorithm. The DSP and AD/DA run at 96KHz sampling rate. The DX0.6 offers a complete processing and crossover solution for any loudspeaker system. We have two models in this range, the DX0.4 with four outputs and the DX0.6 with six outputs. The number of outputs is the only difference between these two models.

The comprehensive signal chain features input gain, delay, noise gate, EQ and routing, to output gain, delay, polarity, cross-over, EQ, Program and Peak limiters. There are a remarkable 14 types of parametric equalizer (PEQ). The output crossover filter includes the classic Linkwitz-Riley, Bessel and Butterworth filter styles with slopes from 6dB/octave up to 48dB/octave.

The newly designed limiter section maintains a maximum level over a slow time constant to restrict the long-term power applied to your speakers. This reduces the possibility of damage and also allows for the short-term peaks that are an essential component of any program material. A second limiter restricts short term peaks to a safe level for the speakers thus providing the best possible solution to keep your sound system working faultlessly.

Each output offers the option to import a maximum 512-taps FIR filter. Used for speaker presets, it can improve the phase response and control the directivity according to your requirements.

Features

- Professional 2-input, 6-output system processor for a wide range of system applications.
- Comprehensive, sophisticated processing options including EQ, gate, delay and limiting to optimise and protect a system.
- Fully assignable matrix routing of both inputs to any output with attenuation option on each routing node.
- Two balanced XLR inputs with up to 12dB of gain, polarity invert, 600ms of delay, 10 band parametric EQ with a choice of 14 filter types individually selectable for each band.
- Six impedance balanced XLR outputs with 12dB of gain, polarity invert, 200ms delay, high and low pass filters with cut-off slopes from -6dB/oct to -48dB/oct using either Bessel, Butterworth or Linkwitz-Riley filters. 8 band parametric EQ with up a choice of 14 filter types, Independent Program and Peak Limiters.
- Convenient front panel controls and LCD display for setting or modifying settings. One press mute buttons for all inputs and outputs.
- Front panel USB port for quick and easy PC connection.
- Networking option using either Ethernet or RS485 for larger systems.
- Output channel preset import function to quickly and easily import a library of output channel presets for Martin Audio loudspeakers.
- Six segment LED metering for input and output level and limiter operation.
- 32 User Presets to store system configurations.
- Three-level customisable user modes with individual password protection.
- Universal switch mode mains PSU accepts 90 to 240V, 50/60Hz.
- Compact 1 rack unit design.
- Approximate shipping weight: 3.5kg.

Getting started

There are two ways to set up your DX0.6. You can:

- Use a desktop app running on a computer connected to your DX0.6. This allows you to access all processor settings and is usually the easiest and best way to set up your DX0.6. You can also use this to control your processor remotely.
- Use the buttons and screen on your DX0.6. This allows you to do a quick update to your settings without the need to connect a computer. You can access most but not all processor settings.



You could use a combination of these methods. For example, you could set up the DX0.6 initially using the desktop app and update settings later using the buttons and screen on the DX0.6.

Desktop app

The desktop app is a Windows app available as a free download from our website martin-audio.com.



We don't support macOS, but we know that some users run this app successfully on virtual platforms such as Parallels Desktop, VMware Fusion and Apple Boot Camp Assistant.

The desktop app has a separate user guide.

To download the desktop app user guide

1. Go to our website martin-audio.com and select **Support > Software**.
2. Scroll to **DX0.4 and DX0.6 Control Software**.
3. Click **USER GUIDE**.

Using the desktop app

To set up your DX0.6 using the desktop app, you need to install the app and connect your processor to your computer.

To install the desktop app

1. Go to our website martin-audio.com and select **Support > Software**.
2. Scroll to **DX0.4 and DX0.6 Control Software**.
3. Click **DOWNLOAD SOFTWARE**.

Connecting your processor and computer

There are four ways of connecting your processor to your computer:

- **USB.** Use a USB cable to connect the USB-B port on the front panel of your processor and a USB port on your computer.



You can only connect one processor at a time with USB.

- **Ethernet direct.** Use a network cable to connect the Ethernet socket on the back panel of your processor directly with the Ethernet socket on your computer.



You can only connect one processor at a time with a direct Ethernet connection.

- **Ethernet network.** Use a network cable to connect the Ethernet socket on the back panel on your unit to the same Ethernet network as your computer.



You can set up and control as many processors as you like with an Ethernet network.

- **RS-485.** Use an RS-485 cable to connect the RS-485 socket on the back panel of your unit and your computer. Very few PCs have an RS-485 socket, so you will almost certainly need an RS-485 RJ45 to USB adaptor. These are readily available and inexpensive.

RS-485 networks are highly robust and the cable runs between devices can be up to 1,200 meters. If you

have several units, you can daisy chain them using the two RS-485 ports on the back panel of each unit.



You can set up and control up to 32 processors with RS-485.

Dynamic or static IP

With an Ethernet network, you can choose dynamic or static IP:

- With dynamic IP a DHCP Server allocates IP Addresses for all devices on the network. For up to about five processors, we recommend dynamic IP. A Wi-Fi router is a good option for small systems, as the router will include a DHCP Server and you could connect your computer to the router using Wi-Fi.
- With static IP you need to specify the IP of each device manually. Static IP is particularly useful for large systems with many processors.

To select dynamic or static IP, use the [desktop app \(page 6\)](#). You can't change this at the front panel of the processor.

Setting up using the front panel

To set up your DX0.6 using the buttons and screen on the front panel, you need to:

- Configure the main settings using the Utility menu. For details, see [Utility menu \(page 10\)](#).
- Configure the input channels. For details, see [Input channels \(page 21\)](#).
- Configure the output channels. For details, see [Output channels \(page 25\)](#).

Controlling front panel access

If you wish, you can control access to the front panel. You do this using the desktop app:

- To add password control of front panel settings, see **User settings** in the [desktop app user guide \(page 6\)](#). Also see [Security utilities \(page 20\)](#).
- To lock all front panel access, see **System locks** in the [desktop app user guide \(page 6\)](#). Note that this even locks the mute buttons.

Connecting your system

To see example system configurations, see [Example systems \(page 30\)](#).

1. Before you connect your equipment, make sure that everything is switched off and the master volume, level or gain controls are all the way down.
2. Connect the line-level outputs from your mixing console (or other signal source) to the inputs of your DX0.6.
3. If you're using amplifiers, connect the outputs from your DX0.6 to the inputs of your amplifiers. Connect the outputs from your amplifiers to the inputs of your passive loudspeakers.

If you're using powered loudspeakers, connect the outputs from your DX0.6 to the inputs of your speakers.
4. Turn on the mixing console (or another signal source).
5. Turn on your DX0.6.
6. Configure the system setup to match your loudspeaker system. See [Getting started \(page 6\)](#).
7. Un-mute the appropriate outputs on your DX0.6.
8. Turn on your amplifiers or powered loudspeakers. Turn up the volume or gain control. In most circumstances, you should turn the gain controls up to maximum so that the amplifier gain matches the limiter threshold levels of the DX0.6.
9. Start the signal source and raise the mixer's main L/R faders up until you can hear audio through the loudspeakers.

Remember

- When you shut down your equipment, turn off the amplifiers first. This is to prevent thumps and other noises generated by upstream equipment from coming out of the speakers.
- When powering up your equipment, turn on the amplifiers last.
- Don't listen to loud music for prolonged periods.

Front panel

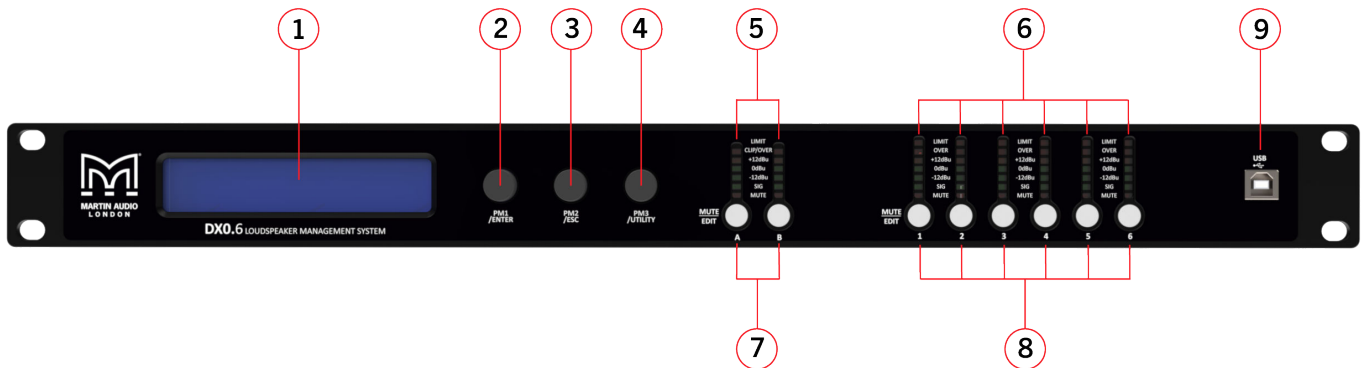

1. The LCD display allows you to view and update the settings on your processor.



You can also set up your processor using a desktop app. For details, see [Desktop app \(page 6\)](#).

2. **PM1/ENTER.** This is a rotary dial that also acts as a push button. To scroll through menus, you rotate this dial left or right. To select a menu item, you press this dial. From now on we will refer to this as **PM1**.
3. **PM2/ESC.** This is also a rotary dial and push button. To edit items, you rotate this dial left or right. To escape from the current menu selection, you press this dial. From now on we will refer to this as **PM2**.
4. **PM3/UTILITY.** This is also a rotary dial and push button. To edit items, you rotate this dial left or right. To select the utility menu, you press this dial. From now on we will refer to this as **PM3**.
5. **Input meters.** Each input has a bar graph of LEDs that acts as a meter:
 - OVER (red) signal level exceeding maximum and clipping.
 - +12dBu (yellow) signal level over +12dBu.
 - 0dBu (green) signal level over 0dBu.
 - -12dBu (green) signal level over -12dBu.
 - SIG (green) signal present minimum -40dBu.
 - Mute (red) channel muted. No levels will appear in the LEDs above.

6. **Output meters.** Each output has a bar graph of LEDs that acts as a meter. These meters are the same as the input meters except that there are two red LEDs at the top rather than one:
 - LIMIT (red) signal level exceeding maximum. Peak limiter operating.
 - OVER (red) signal level exceeding maximum. Program limiter operating.

7. **Input buttons.** These are labelled **A** and **B**. Each button is a mute and edit button:
 - To mute an input, press the appropriate button quickly so that the button lights up red. To unmute, press the button quickly again so that the red light goes out.
 - To edit an input, **press and hold** the button until it lights up blue. To stop editing, press **PM2**.

For details of editing inputs, see [Input channels \(page 21\)](#).

8. **Output buttons.** These are labelled **1** to **6**. Each button is a mute and edit button. These buttons work in exactly the same way as the input buttons.

For details of editing outputs, see [Output channels \(page 25\)](#).

9. **USB-B socket.** You can use this to connect your processor to a computer. Alternatively, you can use the Ethernet or RS485 sockets on the back of your processor. For details, see [Connecting your processor and computer \(page 6\)](#).

Back panel

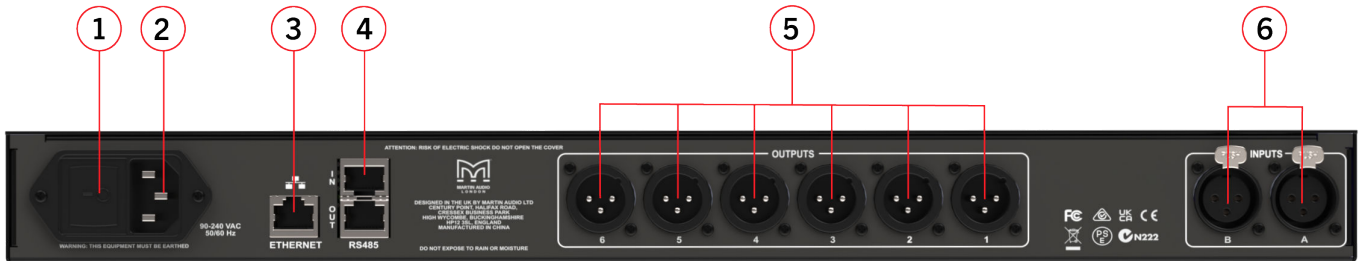

- Power.** To turn the unit on, plug it in and press this switch to "I". To turn it off, press this switch to "O". When the unit is on, the LCD display on the front panel lights up.

 This unit remembers any setting changes, so when you switch the unit on, the unit restarts with the same settings as when you last switched it off.

 The unit uses relays on the outputs to prevent unwanted pops and noise in the system when you switch it on and off. When you switch it on, the unit initialises and the relays switch. Any live outputs will smoothly fade from silence to the configured output levels.
- Power socket.** This IEC input is where you plug in the detachable power cable supplied with your processor. Plug the other end into an AC outlet. If the cable has the wrong mains plug, either use a safety approved IEC cable with the correct plug or ask a qualified electrician to change the plug. Note that the power cable has live, neutral and earth (ground) connected.



Don't disconnect the earth connection. This could be dangerous.

The processor can accept voltages from 100V to 240V AC at frequencies of 50 to 60Hz. You don't need to adjust anything on the unit.

- Ethernet.** The Ethernet port is a standard RJ45 port. This allows you to connect to an Ethernet network with dynamic or static IP. For details, see [Connecting your processor and computer \(page 6\)](#).

 As with most Ethernet ports, there are two LEDs that show the connection state and the network activity.

- RS485.** The upper RJ45 port (labelled **IN**) allows you to connect to an RS485 network. If you have several processors, you can use the lower RJ45 port (labelled **OUT**) to "daisy-chain" the units. For details, see [Connecting your processor and computer \(page 6\)](#).

 The connection uses pins 1 and 2 which are colour coded Orange/white and Orange on standard Cat5e cable.
- XLR Outputs.** The six male XLR connectors provide an impedance balanced line-level signal for each of the output channels. Connect cables between these connectors and the inputs of your power amplifiers or powered loudspeakers.

 Pin 2 is + or "hot", pin 3 is – or "cold" and pin 1 is ground. Connections to unbalanced sources should have signal to pin 2 and ground to pins 1 and 3.

 To see examples of connection set ups, see [Example systems \(page 30\)](#).
- XLR Inputs.** The two female XLR connectors accept a balanced line-level input from a mixer or other source. Pin 2 is + or "hot", pin 3 is – or "cold" and pin 1 is ground. Connections from unbalanced sources should have signal to pin 2 and ground to pins 1 and 3.

 For see examples of connection set ups, see [Example systems \(page 30\)](#).

Utility menu

You can use the utility menu to configure the main settings of the processor.

To use the utility menu

1. Note that before you start, you can press **PM1** or **PM2** and nothing will happen. You can also rotate **PM1**, **PM2** and **PM3** and nothing will happen. For details of these buttons, see [Front panel \(page 8\)](#).
2. Press **PM3**. The screen will display the **Utility Menu** and the first item in the menu which is **System Utilities**.

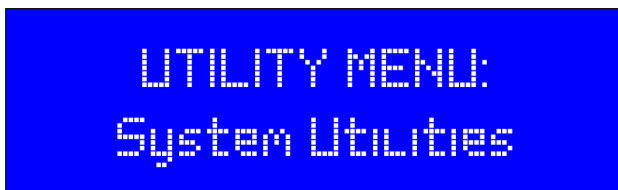

3. Rotate **PM1** to the right and left to scroll through the **Utility Menu**. For details of this menu, see the utility menu section below.
4. Rotate **PM1** to the left until **System utilities** is displayed.
5. Press **PM1** and the screen will show **Input Source** on the bottom line. **Input Source** is the first item in the system utilities menu.
6. Rotate **PM1** to the right and left to scroll through the system utilities menu.
7. Press **PM2** to go back to the main menu.
8. Press **PM2** to exit the main menu. You are now back where you started.

Utility menu choices

From the utility menu, you can choose:

- [System utilities \(page 11\)](#)
- [Program utilities \(page 16\)](#)
- [Network utilities \(page 17\)](#)
- [Security utilities \(page 20\)](#)

These menu choices are described in the following sections.

System utilities

From the system utilities menu, you can set up the following:

- [Input source \(page 11\)](#)
- [Signal generator \(page 11\)](#)
- [Link input \(page 12\)](#)
- [Link output \(page 12\)](#)
- [Linked channel mode \(page 12\)](#)
- [Recall mode \(page 13\)](#)
- [Set factory value \(page 13\)](#)
- [Prevent output clip \(page 13\)](#)
- [Output vu-meter \(page 14\)](#)
- [Firmware version \(page 14\)](#)

These menu choices are described below.

Input source

The input source is either analog input via the XLR inputs at the rear of the processor or internal signal generation.

To configure the internal signal generation, see [Signal generator \(page 11\)](#).

To update the input source

1. Log in as an Admin or Expert. For details, see [Security utilities \(page 20\)](#).



You can only edit this setting if you are logged in as an Admin or Expert.

2. Press **PM3** to display the **Utility Menu**.
3. **System Utilities** will be on the bottom line of the screen. Press **PM1** to select.
4. Input source will appear on the bottom line of the screen. Press **PM1**.
5. To select analog input, rotate **PM2** left so that **Analog Inp** appears on the bottom line of the screen.

Input Source
Source =Analog Inp

To select internal signal generation, rotate **PM2** right so that **Signal Gen** appears on the bottom line of the screen.

6. Press **PM2** to return to the system utility menu.
7. If you have finished editing, press **PM2** two more times.

Signal generator

This allows you to configure the internal signal generator for pink or white noise and the signal level.

To switch on the internal signal generator, see [Input source \(page 11\)](#).

To configure the signal generator

1. Log in as an Admin or Expert. For details, see [Security utilities \(page 20\)](#).



You can only edit this setting if you are logged in as an Admin or Expert.

2. Press **PM3** to display the **Utility Menu**.
3. **System Utilities** will be on the bottom line of the screen. Press **PM1** to select.
4. Rotate **PM1** until **Signal Generator** appears on the bottom line of the screen. Then press **PM1**.

Input Source
Source =Signal Gen

5. To select select pink or white noise, rotate **PM2** so that **Pink** or **White** appears on screen.
6. To change the level, rotate **PM3**. This changes the level **L** up or down by 1dBu (between -30dBu and +10dBu).
7. Press **PM2** to return to the **System Utilities** menu.
8. If you've finished, press **PM2** twice to exit the menu system.

Link input

This allows you to link the inputs A and B.

When you link channels, any setting differences remain unchanged. When you edit a linked channel, the DX0.6 automatically updates linked channels to use the same setting. Note that any unedited settings will remain unchanged.

To link inputs

1. Press **PM3** to display the **Utility Menu**.
2. **System Utilities** will be on the bottom line of the screen. Press **PM1** to select.
3. Rotate **PM1** until **Link Input** appears on the bottom line of the screen. Then press **PM1**.
4. **A** will start flashing to show that you can edit **A**. Rotate **PM3** to the right for **ON** and left for **OFF**.



5. Rotate **PM2** so that **B** starts flashing. Rotate **PM3** to the right for **ON** and left for **OFF**.



To link A and B, set A and B to **ON**.
To unlink A and B, set A and B to **OFF**.

6. Press **PM2** to return to the **System Utilities** menu.
7. If you've finished, press **PM2** twice to exit the menu system.

Link output

This allows you to link output channels. For example, you could link outputs 1 and 2 or you could link all of the outputs.

When you link channels, any setting differences remain unchanged. When you edit a linked channel, the DX0.6 automatically updates linked channels to use the same setting. Note that any unedited settings will remain unchanged.

To link outputs

1. Press **PM3** to display the **Utility Menu**.

2. **System Utilities** will be on the bottom line of the screen. Press **PM1** to select.
3. Rotate **PM1** until **Link Output** appears on the bottom line of the screen. Then press **PM1**.
4. **1** will start flashing to show that you can edit the setting for output 1. Rotate **PM3** to the right for **ON** and to the left for **OFF**.



5. Rotate **PM2** so that **2** starts flashing. Rotate **PM3** to the right for **ON** and left for **OFF**.
6. Rotate **PM2** to update the settings for the rest of the outputs. To see outputs 5 and 6, keep rotating to the right.



Any outputs set to **ON** are linked.
To link all the outputs, set all the outputs to **ON**.

7. Press **PM2** to return to the **System Utilities** menu.
8. If you've finished, press **PM2** twice to exit the menu system.

Linked channel mode

Linked channel mode allows you to choose whether to keep the gain offset between linked channels or not.

For example:

- You have a gain of 0dB for input A and a gain of +3dB for input B.
- You link channels A and B.
- You set linked channel mode for inputs to **ON**.
- You update the gain for channel A to +2db. The DX0.6 will automatically update channel B to have a gain of +5dB (to maintain the offset of 3dB).
- You set linked channel mode for inputs to **OFF**.
- You update the gain for channel A to +1db. The DX0.6 will automatically update channel B to have the same gain of +1dB.

To choose linked channel mode

1. Press **PM3** to display the **Utility Menu**.
2. **System Utilities** will be on the bottom line of the screen. Press **PM1** to select.
3. Rotate **PM1** until **Linked Channel Mode** appears on the bottom line of the screen. Then press **PM1**.
4. To change the setting for inputs, rotate **PM2** to choose **INP= ON** or **OFF**. You can only edit this setting if inputs are linked.



Linked Channel Mode
Offset INP=ON OUT=OFF

5. To change the setting for outputs, rotate **PM3** to choose **OUT= ON** or **OFF**. You can only edit this setting if the outputs are linked.
6. Press **PM2** to return to the **System Utilities** menu.
7. If you've finished, press **PM2** twice to exit the menu system.

Recall mode

Recall mode allows you to choose whether to keep the current channel mute status when you recall a preset. When switched off, the channel mutes will use the settings in the recalled preset. When switched on, the channel mutes will be unchanged when you recall a preset.

You can use this setting to avoid a sudden burst of high-volume sound when you recall a preset. To do this, make sure **Recall mode** is **ON** and mute the channels before you recall a preset.

To change the recall mode

1. Press **PM3** to display the **Utility Menu**.
2. **System Utilities** will be on the bottom line of the screen. Press **PM1** to select.
3. Rotate **PM1** until **Recall mode** appears on the bottom line of the screen. Then press **PM1**.



Recall Mode
Keep Actual Mutes = ON

4. To use the current mute status rather than the preset mute status when you recall a preset, rotate **PM2** to **ON**.

To use the mute settings in the preset when you recall a preset, rotate **PM2** to **OFF**.

5. Press **PM2** to return to the **System Utilities** menu.
6. If you've finished, press **PM2** twice to exit the menu system.

Set factory value

This sets all input and output channels back to the default factory settings. This does not impact settings such as network settings, passwords and user settings.

To set inputs and outputs to factory settings



This will delete all your input and output channel settings. You may want to back up or note your settings before you do this.

1. Press **PM3** to display the **Utility Menu**.
2. **System Utilities** will be on the bottom line of the screen. Press **PM1** to select.
3. Rotate **PM1** until **Set factory value** appears on the bottom line of the screen. Then press **PM1**.



Set Factory Value
(Enter) To Confirm

4. If you are sure this is the right thing to do, press **PM1** to confirm.
5. Press **PM2** to return to the **System Utilities** menu.
6. If you've finished, press **PM2** twice to exit the menu system.

Prevent output clip

The processor has a built-in clip limiter to prevent any of the outputs clipping. This is switched on by default. You can switch the clip limiter on or off as required.

To switch the clip limiter on or off

1. Press **PM3** to display the **Utility Menu**.
2. **System Utilities** will be on the bottom line of the screen. Press **PM1** to select.
3. Rotate **PM1** until **Prevent Output Clip** appears on the bottom line of the screen. Then press **PM1**.

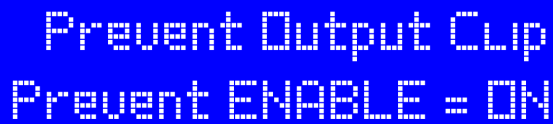

Prevent Output Clip
Prevent ENABLE = ON

4. To switch the clip limiter off, rotate **PM2** left for **OFF**.
To switch the clip limiter on, rotate **PM2** right for **ON**.
5. Press **PM2** to return to the **System Utilities** menu.
6. If you've finished, press **PM2** twice to exit the menu system.

Output vu-meter

This setting allows you to choose whether the front panel output meters display the absolute output level or the pre-limiter level. For details of the output meters, see [Front panel \(page 8\)](#).

- Absolute output level is the default. This is shown in dBu
- Pre-limiter level is the level before limit. This is shown in dB



When you use pre-limiter level the dBu labels on the front panel are no longer relevant.

Pre-limiter level allows you to see at a glance how much system headroom is available. This is particularly useful for signals like the HF drive to a 2 or 3-way system. The output level is likely to be relatively low so the meters will give you very little information. The limiter threshold is also likely to be relatively low as most HF devices have a low power rating. So setting the meter to pre-limiter will show you a much clearer indication of the drive to HF components and how close your signal is to activating the limiter.

To set the output vu-meter

1. Log in as an Admin or Expert. For details, see [Security utilities \(page 20\)](#).



You can only edit this setting if you are logged in as an Admin or Expert.

2. Press **PM3** to display the **Utility Menu**.
3. **System Utilities** will be on the bottom line of the screen. Press **PM1** to select.
4. Rotate **PM1** until **Output Vu-Meter** appears on the bottom line of the screen. Then press **PM1**.
5. To select pre-limiter level, rotate **PM2** left for **Pre-Limiter**. Then press **PM1**.
To select absolute output level, rotate **PM2** right for **After Process**. Then press **PM1**.

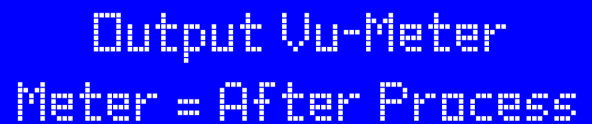

Output Vu-Meter
Meter = After Process

6. Press **PM2** to return to the **System Utilities** menu.
7. If you've finished, press **PM2** twice to exit the menu system.

Firmware version

This allows you to see the current firmware version. FP is the front panel firmware and MB is the motherboard firmware. You only need to take note of the MB version number (if we change FP we always update MB). If you view the firmware version in the [Desktop app \(page 6\)](#), this just shows the MB version number. Note that the desktop app can automatically check whether your firmware is up to date. To do this, the desktop app must be version 1.0.2 or above, the PC needs to be connected to the internet and the DX0.6 needs to be online.

To check the latest firmware version available, go to our website martin-audio.com, select **Support > Software** and scroll to **DX0.4 and DX0.6 Control Software**. This section shows the MB version number.

To download the latest firmware, click the **DOWNLOAD SOFTWARE** button. The firmware is bundled with the software.

To install the latest firmware, click the **FIRMWARE GUIDE** button and follow the instructions.

To view the firmware version

1. Press **PM3** to display the **Utility Menu**.
2. **System Utilities** will be on the bottom line of the screen. Press **PM1** to select.
3. Rotate **PM1** until **Firmware Version** appears on the bottom line of the screen. Then press **PM1**.

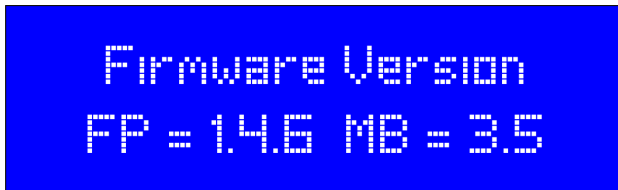

4. Press **PM2** to return to the **System Utilities** menu.
5. If you've finished, press **PM2** twice to exit the menu system.

Program utilities

From the program utilities menu, you can choose:

- [Recall a program \(page 16\)](#)
- [Save a program \(page 16\)](#)

Recall a program

This allows you to recall a system preset or to recall a preset that you have saved previously.

To recall a program

1. Press **PM3** to display the **Utility Menu**.
2. Rotate **PM1** until **Program Utilities** appears on the bottom line of the screen. Then press **PM1**.
3. Rotate **PM1** until **Recall a Program** appears on the bottom line of the screen. Then press **PM1**.



[Enter] To Recall
P31: Flexpoint FP3

4. Rotate **PM1** until the program to recall is shown on the screen.
5. Press **PM1**. The screen will show **[Enter] To Recall**.
6. Press **PM1** to confirm the program recall.
7. If you've finished, press **PM2** twice to exit the menu system.

Save a program

This allows you to save your system settings to one of the 32 presets.

There is only one set of 32 presets, so when you save a setting to a preset you will overwrite the supplied factory preset. If necessary, you can restore the factory settings. For details, see [Set factory value \(page 13\)](#).

To save a program

1. Press **PM3** to display the **Utility Menu**.
2. Rotate **PM1** until **Program Utilities** appears on the bottom line of the screen. Then press **PM1**.
3. Rotate **PM1** until **Save a Program** appears on the bottom line of the screen. Then press **PM1**.



Save a Program
P09: CDD8 FR

4. Rotate **PM1** until the appropriate preset location appears on screen. For example, to store your settings as preset 32, rotate **PM1** until **P32** appears on screen.



Saving a program overwrites the current settings for this preset.

5. Press **PM1** and **Set Program Name** will appear on screen.
6. Edit the name in the same way as for input names. For details, see step 3 and 4 of [Input name \(page 21\)](#). The only difference is that program names can be up to 16 characters.
7. Press **PM1**. The screen will show **[Enter] To Save**.
8. Press **PM1** to confirm.
9. If you've finished, press **PM2** twice to exit the menu system.

Network utilities

You can connect a computer to your processor using either a network (Ethernet or RS485) or a USB cable. For details, see [Connecting your processor and computer \(page 6\)](#).

If you connect using a network, you can use the network utilities menu to set up the following:

- [RS-485 ID \(page 17\)](#)
- [Device name \(page 17\)](#)
- [IP address \(page 17\)](#)
- [Subnet mask \(page 18\)](#)
- [Gateway \(page 18\)](#)
- [LAN mode \(page 18\)](#)

RS-485 ID

This setting allows you to set the ID to use for RS-485. You can set this to a number between 01 and 32.



Each device on RS-485 must have a unique ID.

To set the ID for RS-485

1. Press **PM3** to display the **Utility Menu**.
2. Rotate **PM1** until **Network Utilities** appears on the bottom line of the screen. Then press **PM1**.
3. Rotate **PM1** until **RS485 ID** appears on the bottom line of the screen. Then press **PM1**.
4. To change the ID, rotate **PM2**. Then press **PM2**.



RS-485 ID
SET ID = 05

5. If you've finished, press **PM2** twice to exit the menu system.

Device name

This allows you to give your DX0.6 a name of your choice. The name can be up to 16 characters.

To set the device name

1. Press **PM3** to display the **Utility Menu**.
2. Rotate **PM1** until **Network Utilities** appears on the bottom line of the screen. Then press **PM1**.
3. Rotate **PM1** until **Device name** appears on the bottom line of the screen. Then press **PM1**.
4. To change the name, rotate **PM2** and **PM3** as described in [Input name \(page 21\)](#) steps 3 and 4.



Device Name
Name = DX0.6 Main L/R

5. If you've finished, press **PM2** twice to exit the menu system.

IP address

This allows you to view or set the IP address. You only need to set the IP address if the TCP/IP mode is static.



To change TCP/IP mode (to choose dynamic or static IP), you need to use the [Desktop app \(page 6\)](#).

To view or set the IP address

1. Press **PM3** to display the **Utility Menu**.
2. Rotate **PM1** until **Network Utilities** appears on the bottom line of the screen. Then press **PM1**.
3. Rotate **PM1** until **IP Address** appears on the bottom line of the screen. Then press **PM1** to display the IP address.



The IP address will be all zeros if:

- The processor isn't connected to an Ethernet network.
- The processor is connected to an Ethernet network, the TCP/IP mode is set to dynamic IP and there is no DHCP Server present on the network.

4. To change the IP address, rotate **PM2** and **PM3** as described in [Input name \(page 21\)](#) steps 3 and 4.



You can only edit the IP address if the TCP/IP mode is static IP. You can only change this mode using the [Desktop app \(page 6\)](#).



IP Address
IP Addr=010.011.002.158

5. If you've finished, press **PM2** twice to exit the menu system.

Subnet mask

This allows you to view the subnet mask for the processor.



To edit the subnet mask, you need to use the [Desktop app \(page 6\)](#).

To view the subnet mask

1. Press **PM3** to display the **Utility Menu**.
2. Rotate **PM1** until **Network Utilities** appears on the bottom line of the screen. Then press **PM1**.
3. Rotate **PM1** until **Subnet Mask** appears on the bottom line of the screen. Then press **PM1** to display the subnet mask.



Subnet Mask
SubMask=255.255.255.000

4. Press **PM2** to exit.
5. If you've finished, press **PM2** twice to exit the menu system.

Gateway

This allows you to view the gateway for the processor.



To edit the gateway, you need to use the [Desktop app \(page 6\)](#).

To view the gateway

1. Press **PM3** to display the **Utility Menu**.
2. Rotate **PM1** until **Network Utilities** appears on the bottom line of the screen. Then press **PM1**.
3. Rotate **PM1** until **Gateway** appears on the bottom line of the screen. Then press **PM1** to display the gateway.



Gateway
Gateway=010.011.002.001

4. Press **PM2** to exit.
5. If you've finished, press **PM2** twice to exit the menu system.

LAN mode

This allows you to view the TCP/IP connection mode for the processor. This is either dynamic or static IP.



To edit the LAN mode, you need to use the [Desktop app \(page 6\)](#).

To view the LAN mode

1. Press **PM3** to display the **Utility Menu**.

2. Rotate **PM1** until **Network Utilities** appears on the bottom line of the screen. Then press **PM1**.
3. Rotate **PM1** until **LAN mode** appears on the bottom line of the screen. Then press **PM1**.



The mode is either **DHCP** (for dynamic IP) or **Static IP**.

4. Press **PM2** to exit.
5. If you've finished, press **PM2** twice to exit the menu system.

Security utilities

This allows you to log in or out of your processor as an Admin or Expert. If you haven't logged in (or you've logged out), you are a Basic user.

- Admin users can access all settings.
- Expert users can (by default) access all settings except user settings.
- Basic users can (by default) access many of the settings.

If you are an Admin, you can limit the settings that Basic users and Expert users can access. You do this in the [Desktop app \(page 6\)](#) by updating user settings.



To update passwords and user settings, use the [Desktop app \(page 6\)](#).

You can't update passwords and user settings using the processor.

You remain logged in as an Admin or Expert until you log out (see below) or switch off your processor.

To log in as Admin or Expert



The default Admin password is **111111**

The default Expert password is **222222**

1. Press **PM3** to display the **Utility Menu**.
2. Rotate **PM1** so that **Security Utilities** appears on the bottom line of the screen. Then press **PM1**.
3. **Enter Password Login** will appear. Press **PM1** to select and the first character will flash to show that you can edit this character.

Note that editing passwords is much the same as editing input channel names. For details, see [Input name \(page 21\)](#).
4. To change the flashing character, rotate **PM3**.
5. To move to the next character in the password, rotate **PM2** one click to the right.
6. To change this character, rotate **PM3**. Repeat the last two steps for the rest of the password.



Processor passwords are six characters long.

7. When the password is correct, press **PM1** to log in.

To log out

Switch off your processor or do the following:

1. Press **PM3** to display the **Utility Menu**.
2. Rotate **PM1** so that **Security Utilities** appears on the bottom line of the screen. Then press **PM1**.
3. Rotate **PM2** to the right so that **Logout** appears on the bottom line of the screen.
4. Press **PM1** to log out.

Input channels

To configure the input channels, you use the input buttons in the middle of the front panel. These act as mute and edit buttons. For details, see [Front panel \(page 8\)](#).

To edit the input channels

1. Press and hold the **A** or **B** button until the button goes blue and the input channel menu appears. If you've edited inputs before, the menu item shown will be the last menu item you selected.
2. To move through the menu, rotate **PM1** to the left or right.
3. To select a menu item, press **PM1**. An arrow → will appear bottom left to show that you have selected the item.

For information on each menu item, see the sections below.

4. If you've selected a menu item, press **PM2** to return to the menu.
5. From the menu:
 - To see the same setting on the other channel, press and hold the other input channel button.
 - To update another menu item, rotate **PM1**.
 - To exit the menu, press **PM2**. The channel button blue light will go out.



As soon as you make a change, the DX0.6 saves the change. You don't need to do a separate step to save changes.

Input channel menu

The input channel menu allows you to set up the following:

- Name. See [Input name \(page 21\)](#).
- N. Gate. See [Input noise gate \(page 22\)](#).
- Gain. See [Input gain \(page 22\)](#).
- Polarity. See [Input polarity \(page 22\)](#).
- Delay. See [Input delay \(page 23\)](#).
- EQ E/N. See [Enable input EQ \(page 23\)](#).
- PEQ-01 to PEQ-10. See [Ten band input EQ \(page 23\)](#).

Input name

This allows you to change the input channel name to anything you like (up to six characters). The input channel names are **In L** and **In R** by default.

To change the input channel name

1. Press the **A** or **B** button until the button goes blue and the channel menu appears. For details, see [Input channels \(page 21\)](#).
2. If **Name** is shown on the screen, press **PM1** to select this from the menu. If not, rotate **PM1** to the left until **Name** appears and then press **PM1**.

The first character of the name will start flashing to show that you can edit this character.



3. Rotate **PM3** to change the first character, for example from B to C.

For lower case letters, keep rotating **PM3** to the right.

For numbers, rotate **PM3** to the left of the upper case letters.

When you rotate **PM3**, the order of the characters is as follows:



4. Rotate **PM2** to move forward and back along the name. The character to edit will start flashing. Then use **PM3** to change this character.
5. When you've finished editing, press **PM2** to return to the menu. To see what you can do next, see [Input channels \(page 21\)](#) step 5.

Input noise gate

The input noise gate allows you to automatically reduce the level of background noise from the inputs. This allows you to reduce hum or hiss. You can set the threshold, release time and attack time:

- **Threshold** is the input level where the noise gate opens to let the signal through.
- **Release time** specifies how quickly the gate closes. It is the time after the input level drops below the threshold and before the gate closes.
- **Attack time** specifies how quickly the gate opens. This is the time after the input level goes above the threshold and before the gate opens.

To edit the input noise gate

1. Press the **A** or **B** button until the button goes blue and the channel menu appears. For details, see [Input channels \(page 21\)](#).
2. Rotate **PM1** until **N. Gate** appears at the top right of the screen and press **PM1**.
3. To switch the noise gate on or off, rotate **PM1** until **Enable** is shown bottom left. Then rotate **PM2** to select **ON** or **OFF**.
4. To set the threshold (see above), rotate **PM1** until **Threshold** is shown bottom left. Then rotate **PM2** to increase or decrease the threshold in 5dBu steps (between -45 and -80dBu).
5. To set the release time (see above), rotate **PM1** until **Rel Time** is shown bottom left. Then rotate **PM2** to increase or decrease the time in milliseconds (between 1ms and 1s).
6. To set the attack time (see above), rotate **PM1** until **Atk Time** is shown bottom left. Then rotate **PM2** to increase or decrease the time in milliseconds (between 1ms and 1s).
7. When you've finished editing, press **PM2** to return to the menu. To see what you can do next, see [Input channels \(page 21\)](#) step 5.



Input gain

The input gain allows you to adjust the entire system levels up and down. You can use this to compensate for variations in the signal level of the program material from your signal source.

You can adjust the input between +12 and -18dB.

To change the input gain

1. Press the **A** or **B** button until the button goes blue and the channel menu appears. For details, see [Input channels \(page 21\)](#).
2. Rotate **PM1** until **Gain** appears at the top right of the screen and press **PM1**.
3. Rotate **PM2** to adjust the gain in 1dB steps.
4. Rotate **PM3** to adjust the gain in 0.1dB steps. This gives you more precise control.
5. When you've finished editing, press **PM2** to return to the menu. To see what you can do next, see [Input channels \(page 21\)](#) step 5.

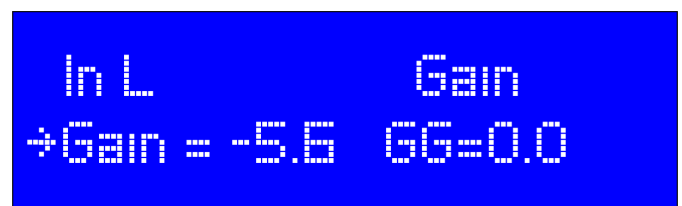

GG (shown bottom right of the screen) is Group Gain. This is gain added to the channel from a group.



To set up Group Gain, you need to use the [Desktop app \(page 6\)](#).

Group Gain is designed for system projects with multiple processors. Group Gain can vary between +12 and -18dB and is summed with the channel gain. For example, if you set the channel gain to +6dB and the group gain to -3dB, the net gain for the input will be +3dB.

Input polarity

Polarity allows you to invert the input channel, adding a 180° phase shift.

To change the input polarity

1. Press the **A** or **B** button until the button goes blue and the channel menu appears. For details, see [Input channels \(page 21\)](#).
2. Rotate **PM1** until **Polarity** appears at the top right of the screen and press **PM1**.
3. Rotate **PM2** left to select **Inverted** or right to select **Normal**.
4. When you've finished editing, press **PM2** to return to the menu. To see what you can do next, see [Input channels \(page 21\)](#) step 5.

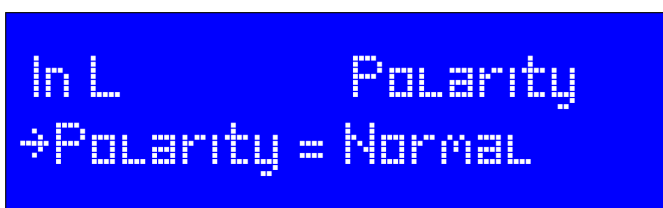

Input delay

Input delays are useful for time aligning components of a system either to each other or to live instruments or to both. You can set the delay as time or distance, as follows:

- Time in milliseconds (0 to 600.979)
- Distance in meters (0 to 204.332)
- Distance in feet (0 to 670.383)

To set the input delay

1. Press the **A** or **B** button until the button goes blue and the channel menu appears. For details, see [Input channels \(page 21\)](#).
2. Rotate **PM1** until **Delay** appears at the top right of the screen and press **PM1**.
3. To select **ms** for milliseconds, **M** for meters or **ft** for feet, rotate **PM1**.
4. To make course adjustments ($\pm 1.000\text{ms}$, $\pm 0.340\text{m}$ or $\pm 1.115\text{ft}$), rotate **PM2**.
5. To make fine adjustments. ($\pm 0.0208\text{ms}$, $\pm 0.007\text{m}$ or $\pm 0.023\text{ft}$), rotate **PM3**.
6. When you've finished editing, press **PM2** to return to the menu. To see what you can do next, see [Input channels \(page 21\)](#) step 5.



Enable input EQ

This allows you to bypass the entire ten band input EQ. You can use this to quickly compare the sound with or without the input EQ. It doesn't change any of the individual EQ parameters. For details of the ten band input EQ, see [Ten band input EQ \(page 23\)](#).

To switch input EQ on or off

1. Press the **A** or **B** button until the button goes blue and the channel menu appears. For details, see [Input channels \(page 21\)](#).
2. Rotate **PM1** until **EQ E/N** appears at the top right of the screen and press **PM1**.
3. To switch EQ off, rotate **PM2** left to select **OFF**.
To switch EQ on, rotate **PM2** right to select **ON**.
4. When you've finished editing, press **PM2** to return to the menu. To see what you can do next, see [Input channels \(page 21\)](#) step 5.



Ten band input EQ

There are ten bands of parametric EQ (PEQ) available on each input channel. Each band is identical and you can edit the type, frequency, gain, Q and slope.

The input EQ is useful for adjusting the response of the entire sound system, particularly when correcting anomalies caused by venue acoustics. You can then use output EQ for any recommended speaker EQ. For details, see [Eight band output EQ \(page 29\)](#).

To edit the ten band input EQ

1. Press the **A** or **B** button until the button goes blue and the channel menu appears. For details, see [Input channels \(page 21\)](#).

2. If EQ is off, you need to switch it on. For details, see [Enable input EQ \(page 23\)](#).



You can only switch on EQ bands if EQ is on.

3. Rotate **PM1** until the appropriate EQ band (**PEQ-01** to **PEQ-10**) appears at the top right of the screen and press **PM1**.

For example, to select the tenth band of EQ, rotate **PM1** until **PEQ-10** appears top right and press **PM1**.

4. To switch this EQ band on or off, rotate **PM1** until **E/N** is shown bottom left. Then rotate **PM2** left to select **OFF** or right to select **ON**.



You can only edit the type, frequency, gain, Q and slope if the EQ band is switched on.

5. To select the **Type**, rotate **PM1** until **E/N** is shown bottom left and **Type** bottom right. Make sure **E/N** is **ON** and then rotate **PM3** to choose the type.

For a list of the types available, see the table below.

6. To update the frequency, make sure **E/N** is **ON** and rotate **PM1** until **Frequency** is shown bottom left.

To change the frequency in steps of 100Hz, rotate **PM2**.

To change the frequency in steps of 1Hz, rotate **PM3**.

The minimum value is 20Hz and the maximum depends on the type.

7. To update the gain, make sure **E/N** is **ON** and rotate **PM1** until **Gain** is shown bottom left.

To move the gain up or down by 0.1dB rotate **PM2** (between -15dB to +15dB).



You can only edit gain for some EQ types.

8. To update Q, make sure **E/N** is **ON** and rotate **PM1** until **Gain** is shown bottom left and **Q** bottom right. Then rotate **PM3** to change the Q value.



You can only edit Q for some EQ types.

9. To update slope (**S**), make sure **E/N** is **ON** and rotate **PM1** until **Gain** is shown bottom left and **S** bottom right. Then rotate **PM3** to change the slope value.



You can only edit slope for some EQ types.

10. When you've finished editing, press **PM2** to return to the menu. To see what you can do next, see [Input channels \(page 21\)](#) step 5.

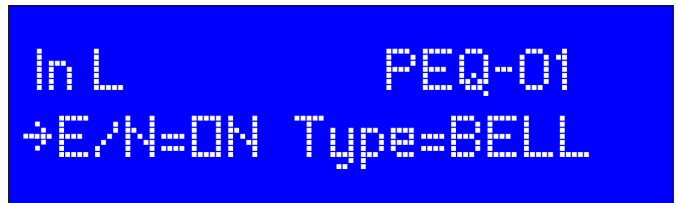

EQ types

Name on screen	Description
BELL	Bell (constant Q). This is the default.
HiShvS	High shelf with preset slope
HiShvQ	High shelf with variable Q
LoShvS	Low shelf with preset slope
LoShvQ	Low shelf with variable Q
LP 1st	Low pass first order (classic 6dB/Oct)
LP 2nd	Low pass second order (classic 6dB/Oct)
LP Q	Low pass with variable Q (classic 6dB/Oct)
HP 1st	High pass first order (classic 12dB/Oct)
HP 2nd	High pass second order (classic 12dB/Oct)
HP Q	High pass with variable Q (classic 12dB/Oct)
Notch	Notch
AllPs1	All pass first order
AllPs2	All pass second order

Output channels

To edit the output channels, use the output buttons on the right of the front panel. These act as mute and edit buttons. For details, see [Front panel \(page 8\)](#).

The output settings allow you to

- Achieve the best possible performance from your speaker system.
- Minimise the possibility of damage due to excessive sound levels.

To edit the output channels

1. Press and hold the appropriate output button until the button goes blue and the channel menu appears. For example, to edit channel one, press and hold button **1**. If you've edited outputs before, the menu item shown will be the menu item from last time.
2. To move through the menu, rotate **PM1** to the left or right.
3. To select a menu item, press **PM1**. An arrow → will appear bottom left to show that you have selected the item.

For information on each menu item, see the sections below.

4. If you've selected a menu item, press **PM2** to return to the menu.
5. From the menu:
 - To see the same setting on another output channel, press and hold the other output channel button.
 - To update another menu item, rotate **PM1**.
 - To exit the menu, press **PM2**. The channel button blue light will go out.



As soon as you make a change, the DX0.6 saves the change. You don't need to do a separate step to save changes.

Output channel menu

The output channel menu allows you to set up the following:

- Name&FCP. See [Output name \(page 25\)](#) and [Resetting a channel to factory defaults \(page 26\)](#)

- Source. See [Output source \(page 26\)](#)
- Gain. See [Output gain \(page 26\)](#)
- Polarity. See [Output polarity \(page 27\)](#)
- Delay. See [Output delay \(page 27\)](#)
- Peak Lim. See [Peak limiter \(page 27\)](#)
- Prog Lim. See [Program limiter \(page 27\)](#)
- FIR E/N. See [Output FIR enable \(page 28\)](#)
- HPF. See [High pass filter \(page 28\)](#)
- LPF. See [Low pass filter \(page 28\)](#)
- EQ E/N. See [Enable output EQ \(page 29\)](#)
- PEQ-01 to PEQ-08. See [Eight band output EQ \(page 29\)](#)

Output name

You can change each output channel name to anything you like (up to six characters).

To change the output channel name

1. Press the appropriate output button **1** to **6** until the button goes blue and the channel menu appears. For details, see [Output channels \(page 25\)](#).
2. Changing input and output channel names is almost identical, so use the instructions in [Input name \(page 21\)](#) starting at step 2.

The only difference is that for output channels, you select **Name+FCP** rather than **Name**.



FCP is Factory Channel Preset. For details, see [Resetting a channel to factory defaults \(page 26\)](#).

CH-4 Name+FCP
→Name = SUB R

Resetting a channel to factory defaults

You can reset any output channel back to the factory default settings. This will set gain at 0dB, delay at 0ms, flat EQ, high and low pass filters bypassed and so on. This is a quick way to start with a “blank canvas”. This also allows you to reset an output that has a locked output channel preset. The locking of presets stops anyone updating parameters that might adversely affect speaker performance (crossover slopes, equalisation and limiter settings).

The library of Martin Audio speaker output presets bundled with the [desktop application \(page 6\)](#) are all locked. This ensures that the speaker preset produces exactly the audio quality intended when the Martin Audio Research and Development team designed the speaker. You can also create your own locked presets so that no one can tamper with your settings.

The downside of locked presets on every output is that you can no longer use your processor for anything else. Resetting a channel to factory defaults allows you to freely edit the output channel settings again.

To reset a channel to factory defaults

1. Press the appropriate output button **1** to **6** until the button goes blue and the channel menu appears. For details, see [Output channels \(page 25\)](#).
2. Rotate **PM1** until **Name&FCP** is shown top right and press **PM1** to select. FCP is Factory Channel Preset.
3. Rotate **PM1** until **Recall Factory CHPreset** is shown on the bottom line.
4. Press **PM1** to select.



Resetting this channel will lose all your parameter settings for the channel.

5. **Recall Channel Preset?** will appear on screen. Press **PM1** to confirm and the channel will now reset to the factory defaults.
6. When you've finished editing, press **PM2** to return to the menu. To see what you can do next, see [Output channels \(page 25\)](#) step 5.

Output source

This allows you to select the input source that will be routed to this output channel.

You can also set the gain for this channel from 0db down to -30dB. This is useful where both input channels A and B are routed to the same output for mono applications such as subs, front fills, delays and so on. Two similar input signals will naturally sum producing a louder output. You can compensate for this by adding a few dB of attenuation.

To update the source

1. Press the appropriate output button **1** to **6** until the button goes blue and the channel menu appears. For details, see [Output channels \(page 25\)](#).
2. Rotate **PM1** until **Source** appears top right. Then press **PM1**.
3. To choose the input channel name, rotate **PM1**.
4. To switch the input channel on or off, rotate **PM2** to the left for **OFF** or right for **ON**.
5. To change the **Gain** (see above), rotate **PM3**.
6. When you've finished editing, press **PM2** to return to the menu. To see what you can do next, see [Output channels \(page 25\)](#) step 5.



Output gain

The output gain allows you to adjust the entire system levels up and down. You can use this to compensate for variations in the signal level of the program material from your signal source.

You can adjust the output gain between +12 and -18dB.

To change the output gain

1. Press the appropriate output button **1** to **6** until the button goes blue and the channel menu appears. For details, see [Output channels \(page 25\)](#).
2. Changing input and output gain is almost identical, so use the instructions in [Input gain \(page 22\)](#) starting at step 2.

Output polarity

Polarity allows you to invert the output channel, adding a 180° phase shift.

To change the output polarity

1. Press the appropriate output button **1** to **6** until the button goes blue and the channel menu appears. For details, see [Output channels \(page 25\)](#).
2. Changing input and output polarity is almost identical, so use the instructions in [Input polarity \(page 22\)](#) from step 2.

Output delay

Output delays are useful for time aligning components of a system to each other or live instruments or both.

To update the output delay

1. Press the appropriate output button **1** to **6** until the button goes blue and the channel menu appears. For details, see [Output channels \(page 25\)](#).
2. Updating input and output delay is almost identical, so use the instructions in [Input delay \(page 23\)](#) starting at step 2.

Peak limiter

The peak limiter is designed to restrict short term peaks in the music signal to prevent damage from excessive cone excursion in the speaker drivers. You specify a peak limit and the processor adds this limit to the program limiter. The program limiter protects against long term excessive power. For details, see [Program limiter \(page 27\)](#).

The peak threshold is the program limiter plus the peak limiter.

Note that we quote the figures for the power rating for Martin Audio speakers in AES Watts with the peak rating 4X (6dB) higher than the AES figure.

You set the peak limiter by setting a threshold and a release time.

To set the peak limiter

1. Press the appropriate output button **1** to **6** until the button goes blue and the channel menu appears. For details, see [Output channels \(page 25\)](#).
2. To change the peak limit, rotate **PM1** until **Peak Lim** is shown top right and press **PM1** to select. Then:

- Rotate **PM2** to change the peak limit (**ThrOf**) in 1dBu steps.
- Rotate **PM3** to change the peak limit in 0.1dBu steps. This allows fine control.



PT shown bottom right is the Peak Threshold. This is the total of the Program Limiter and the Peak Limiter. The maximum Peak Threshold is 20dBu.

3. To change the release time, rotate **PM1** so that **Rel Time** appears on the bottom line of the screen. Then rotate **PM2** to select one of the following release times:
 - Slow = 800ms
 - Mid = 350ms
 - Fast = 91ms
4. When you've finished editing, press **PM2** to return to the menu. To see what you can do next, see [Output channels \(page 25\)](#) step 5.

Program limiter

The Program limiter allows you to control the long-term power applied to your speakers. This protects your speakers from damage caused by the voice coil overheating.

You can set the program limiter threshold, the release time and the attack time.



The DX0.6 also has a peak limiter. For details, see [Peak limiter \(page 27\)](#).

To set the program limiter

1. Press the appropriate output button **1** to **6** until the button goes blue and the channel menu appears. For details, see [Output channels \(page 25\)](#).
2. To change the threshold, rotate **PM1** until **Prog Lim** is shown top right and press **PM1** to select. Then:
 - Rotate **PM2** to change the **Threshold** in 1dBu steps.

- Rotate **PM3** to change the **Threshold** in 0.2dBu steps.
3. To change the release time, rotate **PM1** so that **Rel Time** appears on the bottom line of the screen. Then rotate **PM2**.
 4. To change the attack time, rotate **PM1** so that **Atk Time** appears on the bottom line of the screen. Then rotate **PM2**.
 5. When you've finished editing, press **PM2** to return to the menu. To see what you can do next, see [Output channels \(page 25\)](#) step 5.

Output FIR enable

FIR enable allows you to switch FIR EQ filters on or off. FIR is Finite Impulse Response.



To load FIR EQ filters you need to use the [Desktop app \(page 6\)](#). You can't load FIR EQ filters using the processor.

To switch FIR on or off

1. Log in as an Admin or Expert. For details, see [Security utilities \(page 20\)](#).



You can only switch FIR on or off if you are logged in as an Admin or Expert.

2. Press the appropriate output button **1** to **6** until the button goes blue and the channel menu appears. For details, see [Output channels \(page 25\)](#).
3. Rotate **PM1** until **FIR E/N** appears top right. Press **PM1** to select.
4. To switch on FIR, rotate **PM2** right to select **ON**. To switch off FIR, rotate **PM2** left to select **OFF**.
5. When you've finished editing, press **PM2** to return to the menu. To see what you can do next, see [Output channels \(page 25\)](#) step 5.

High pass filter

You can use the high pass filter along with the [Low pass filter \(page 28\)](#) to set up crossovers in a multi-way loudspeaker and subwoofer system. You can also use a

high pass filter to roll-off low frequencies that a full-range loudspeaker cannot efficiently reproduce and that may cause damage to the speaker.

To edit the high pass filter

1. Press the appropriate output button **1** to **6** until the button goes blue and the channel menu appears. For details, see [Output channels \(page 25\)](#).
2. Rotate **PM1** until **HPF** is shown top right and press **PM1** to select.
3. To change the frequency in 100Hz steps, rotate **PM2**.
4. To change the frequency in 1Hz steps, rotate **PM3**.
5. To change the slope, rotate **PM1** so that **Slope** appears on the bottom line of the screen. Then rotate **PM2** to select the slope. For a list of the slopes available, see the table below.
6. When you've finished editing, press **PM2** to return to the menu. To see what you can do next, see [Output channels \(page 25\)](#) step 5.

High and low pass filter slopes

Name on screen	Description
Bypass	Bypass
-6dB BW	Butterworth -6dB/octave
-12dB BW	Butterworth -12dB/octave
-12dB LR	Linkwitz-Riley -12dB/octave
-12dB BS	Bessel -12dB/octave
-18dB BW	Butterworth -18dB/octave
-24dB BW	Butterworth -24dB/octave
-24dB LR	Linkwitz-Riley -24dB/octave
-24dB BS	Bessel -24dB/octave
-36dB BW	Butterworth -36dB/octave
-36dB LR	Linkwitz-Riley -36dB/octave
-48dB BW	Butterworth -48dB/octave
-48dB LR	Linkwitz-Riley -48dB/octave

Low pass filter

You can combine the low pass filter and the [High pass filter \(page 28\)](#) to set up crossovers in multi-way loudspeaker and subwoofer systems. This will allow you to make the system sound its best and operate most efficiently. For example, with a three-way stereo system, you could use the high and low pass filters on the outputs feeding the low, mid and high range transducers so that each transducer is reproducing the range for which it is best suited.

To edit the low pass filter

1. Press the appropriate output button **1** to **6** until the button goes blue and the channel menu appears. For details, see [Output channels \(page 25\)](#).
2. Rotate **PM1** until **LPF** is shown top right and press **PM1** to select.
3. To change the frequency in 100Hz steps, rotate **PM2**. To change the frequency in 1Hz steps, rotate **PM3**.
4. To change the slope, rotate **PM1** so that **Slope** appears on the bottom line of the screen. Then rotate **PM2** to select the slope. For a list of the slopes available, see the table in the section [High pass filter \(page 28\)](#).
5. When you've finished editing, press **PM2** to return to the menu. To see what you can do next, see [Output channels \(page 25\)](#) step 5.

Enable output EQ

This allows you to bypass the entire eight band output EQ. You can use this to quickly compare the sound with and without the output EQ. It doesn't change any of the individual EQ parameters. For details of the eight band output EQ, see [Eight band output EQ \(page 29\)](#).

To switch the output EQ on or off

1. Press the appropriate output button **1** to **6** until the button goes blue and the channel menu appears. For details, see [Output channels \(page 25\)](#).
2. Switching input and output EQ on and off is almost identical, so use the instruction in [Enable input EQ \(page 23\)](#) starting at step 2.

Eight band output EQ

There are eight bands of parametric EQ (PEQ) available on each output channel. Each band is identical and you can edit the type, frequency, gain, Q and slope.

You can use output EQ to adjust the response of a particular loudspeaker or transducer and to correct for room anomalies in multi-room setups.

In addition to output EQ, the DX0.6 has ten bands of input EQ. For details, see [Ten band input EQ \(page 23\)](#).

To change the eight band output EQ

1. Press the appropriate output button **1** to **6** until the button goes blue and the channel menu appears. For details, see [Output channels \(page 25\)](#).

2. If EQ is currently off, switch it on, as explained in [Enable output EQ \(page 29\)](#).



You can only switch on EQ bands if EQ is on.

3. Setting up input and output EQ is almost identical, so use the instructions in [Ten band input EQ \(page 23\)](#) starting at step 3.

Example systems

The following sections show hook-up diagrams for six example system setups:

- [BlacklineX12 and X118 subs \(page 30\)](#)
- [O-Line arrays and SX112 subs \(page 30\)](#)
- [Two pairs of LE200 monitors \(page 31\)](#)
- [CDD12, CDD6 and SX212 subs \(page 31\)](#)
- [THV and SX118 subs \(page 32\)](#)
- [BlacklineX12 and SXC115 subs \(page 32\)](#)

For an example of how to configure a system using the desktop app, see the section **Configuring an example system** in the [desktop app user guide \(page 6\)](#).

BlacklineX12 and X118 subs

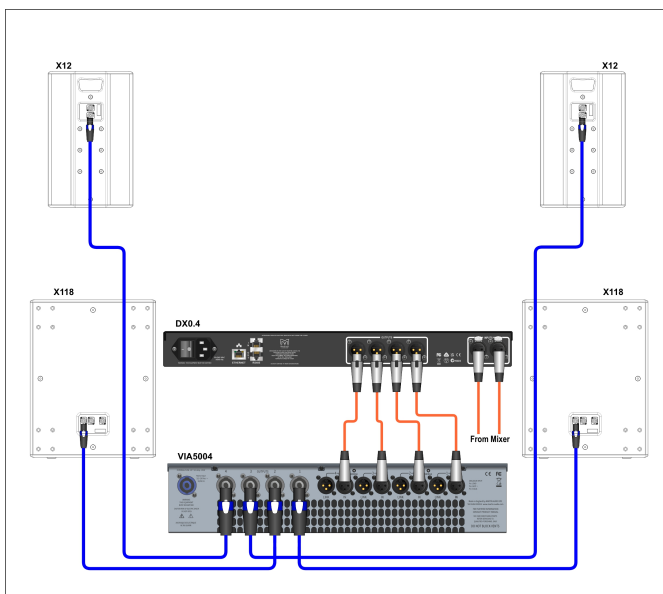

This system is a typical BlacklineX portable system suitable for gigging bands and DJs in pubs, bars and small clubs. You configure the DX0.4 to run the system in stereo and the system is driven actively bi-amped. The left and right line-level XLR outputs from a mixer feed the A and B XLR inputs of the DX0.4 Processor.

The XLR outputs 1 to 4 of the DX0.4 feed the XLR inputs 1 to 4 of a Martin Audio VIA5004 four-channel power amplifier.

The CH1 and CH2 NL4 speaker outputs of the power amplifier feed two Martin Audio X118 subwoofers located either side of the stage.

The CH3 and CH4 NL4 speaker outputs of the amplifier feed the inputs of two Martin Audio X12 loudspeakers. These are positioned on top of the X118s using a distance bar (such as the HTKCT04) to get good height on the X12s. This ensures that the higher frequencies aren't blocked by audience members.

To configure the DX0.4, you recall the output presets for the X118 and X12 to the appropriate channels.

O-Line arrays and SX112 subs

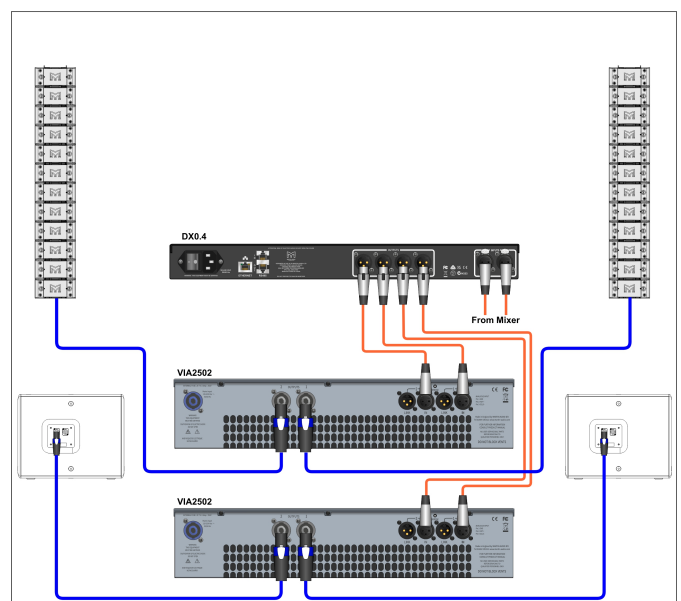

This system features two 12 box O-Line arrays and a pair of SX112 subwoofers. This is a typical system for lecture theatres, conference rooms and small houses of worship where vocal clarity and dispersion is the priority. You could also use this system for pre-recorded music, requiring a full range performance.

Left and right from the mixer feed inputs A and B of the DX0.4 or DX0.6. The outputs feed two independent amplifiers, this time each amplifier is a Martin Audio VIA2502. Outputs 1 and 2 are sub out; you can configure these feeds in mono, as there is no stereo information in the sub band.

The outputs of the sub VIA2502 feed the NL4 inputs of the two SX112 subwoofers. In the diagram shows them positioned left and right but they would perform well centrally next to each other if there is a suitable location in the venue, such as under a stage. A central configuration of subs will avoid the inevitable "power

alley” that a left and right deployment will always produce.

Outputs 3 and 4 from the DX0.4 or DX0.6 route to the inputs of the second VIA2502. The outputs from this amplifier route to the O-Line arrays.

In this example, you could configure outputs 1 and 2 using the output presets for the SX112. To calculate the equalisation for the O-Line array, use Martin Audio's **Display 2** software (see martin-audio.com/support/software) and select the option for Passive EQ in the EQ tab. Note that a fully optimised O-Line array isn't possible with the DX0.4 and DX0.6 processors. For that, you need a DX4.0 controller or an iKON amplifier.

Two pairs of LE200 monitors

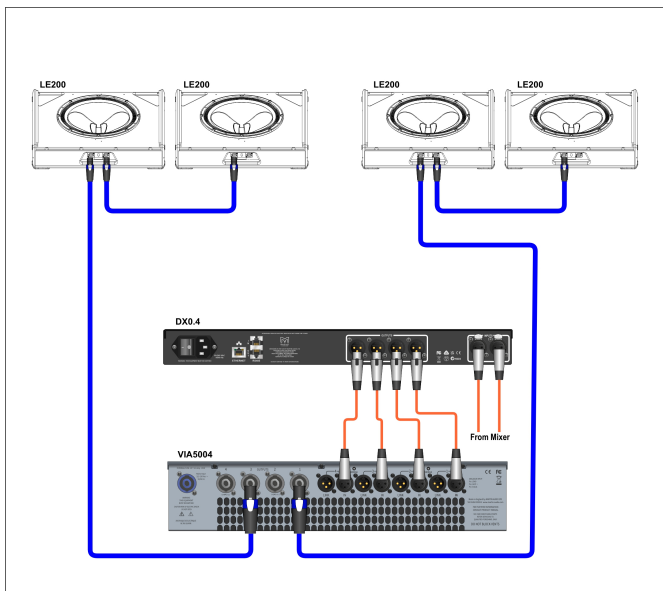

This system uses the DX0.4 or DX0.6 as a two-channel crossover to run two pairs of LE200 monitors in bi-amp mode. This would suit a duo playing clubs or larger venues who need good quality monitors on a tight budget. The LE200 monitors use the CDD driver technology to give phenomenal stage coverage in a lightweight low-profile enclosure. Bi-amping gives the ultimate control to produce the best possible sound quality.

The inputs of the DX0.4 or DX0.6 are fed from the system mixer. With this setup, the monitor feeds will usually be from pre-fade auxiliary sends, either from the front of house mixer or from a dedicated monitor desk.

The system uses a four channel Martin Audio VIA5004 which saves rack space, weight and cost. Outputs 1 to 4 from the DX0.4 or DX0.6 are routed to inputs 1 to 4 on the amplifier. Channels 1 and 2 drive the low frequency

and high frequency of the first pair of monitors. Channels 3 and 4 do the same for the second pair.

All four monitors need to be switched to bi-amp on the input connector panel. This routes the signals on channel 1+/- of the NL4 connectors to the low frequency section of the driver and channels 2+/- to the compression driver.

The speaker cable will need to be 4 core. All four channels must be wired to the NL4 at both ends. The NL4s at the amplifier outputs connect to outputs 1 and 3, these carry not just that channel output on pins 1+/- but also the next channel on pins 2+/- specifically to make it easy to power bi-amped speakers. This ensures that both low and high frequency signals are routed down the single cable.

The pairs of LE200s are linked with a short 4-core NL4 lead. The diagram shows these cables connecting to the main connector panel, but it may be neater to use the parallel connectors in the handle pockets.

To configure the DX0.4 or DX0.6, you use the output channel presets for the LE200 LF and HF recalled on the appropriate channels.

CDD12, CDD6 and SX212 subs

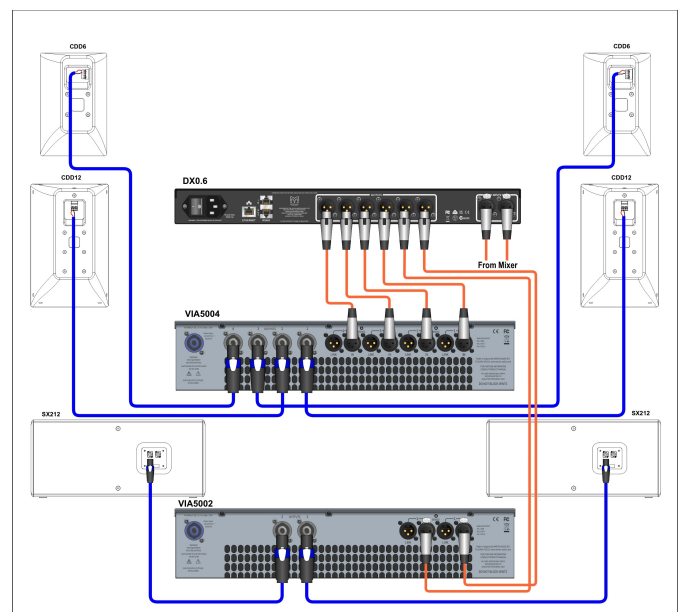

This is a permanently installed system featuring two models from the CDD range, the CDD12 and CDD6, coupled with a pair of SX212 subs. This would be a suitable installed system in a bar where the main area is covered by the CDD12 and where a secondary space is covered by the CDD6. This system uses the DX0.6 as the system processor taking a feed from a signal source such as a mixer. The system is run in stereo with DX0.6 outputs 1 and 2 feeding the subwoofer, outputs 3 and 4

controlling the CDD12 and outputs 5 and 6 controlling the CDD6.

The system uses two Martin Audio amplifiers:

- One VIA5004 four-channel amplifier to drive the CDD12 and CDD6 speakers.
- One VIA5002 two-channel amplifier to drive the SX212 subwoofers.

Six short XLR cables link the DX0.6 to the amplifiers.

- DX0.6 outputs 1 and 2 go to VIA5002 inputs 1 and 2.
- DX0.6 outputs 3, 4, 5 and 6 go to VIA5004 inputs 1, 2, 3 and 4.

Four NL4 to bare end speaker cables connect the VIA5004 (outputs 1, 2, 3 and 4) to the CDD speakers (Phoenix style connectors).

Two standard NL4 speaker cables connect the VIA5002 (outputs 1 and 2) and the two SX212 subs.

THV and SX118 subs

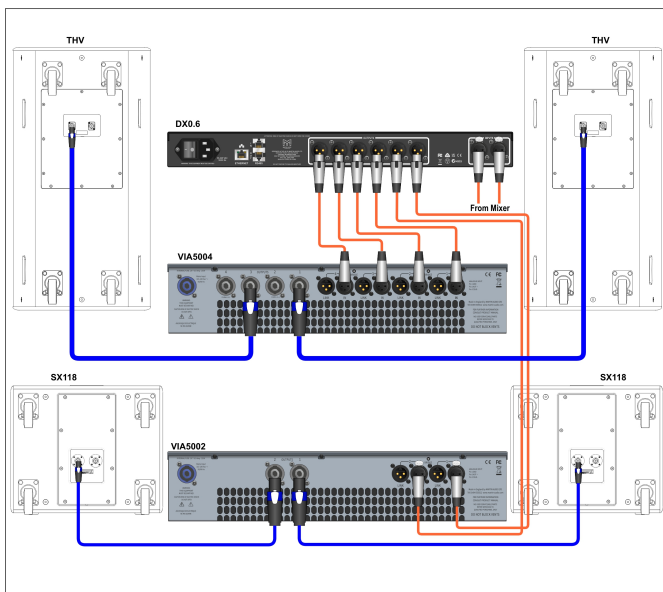

This is a portable system featuring a pair of THV three-way bi-amped fully horn loaded speakers and a pair of SX118 single 18" subwoofers. This would be an ideal system for gigging bands or DJs in larger clubs, bars and live music venues. The horn loading of the THV will help to project the sound, giving extra SPL and good dispersion control.

The DX0.6 is configured as a stereo three-way crossover.

- Outputs 1 and 2 are programmed with the output presets for the SX118 subwoofers.

- Outputs 3 and 4 are configured with the THV LF output presets.
- Outputs 5 and 6 are configured with the THV HF output preset.

DX0.6 input A is routed to outputs 1, 3 and 5.

DX0.6 input B is routed to outputs 2, 4 and 6.

The subs could be run in mono by also routing input A to output 2 and routing input B to output 1.

Short XLR cables connect the DX0.6 outputs to the amplifier inputs.

- DX0.6 outputs 1 and 2 connect to VIA5002 inputs 1 and 2.
- DX0.6 outputs 3, 4, 5 and 6 connect to VIA5004 inputs 1, 2, 3 and 4.

Two more NL4 speaker cables connect the outputs of the VIA5004 to the inputs on the THV. Note that these cables must be 4-core. One connection is made to channel 1 output which also has channel 2 wired to pins 2+/-, and the second cabinet to channel 3 output which also has channel 4 on pins 2+/- . This ensures that both LF and HF signals are fed to the speakers down a single cable.

BlacklineX12 and SXC115 subs

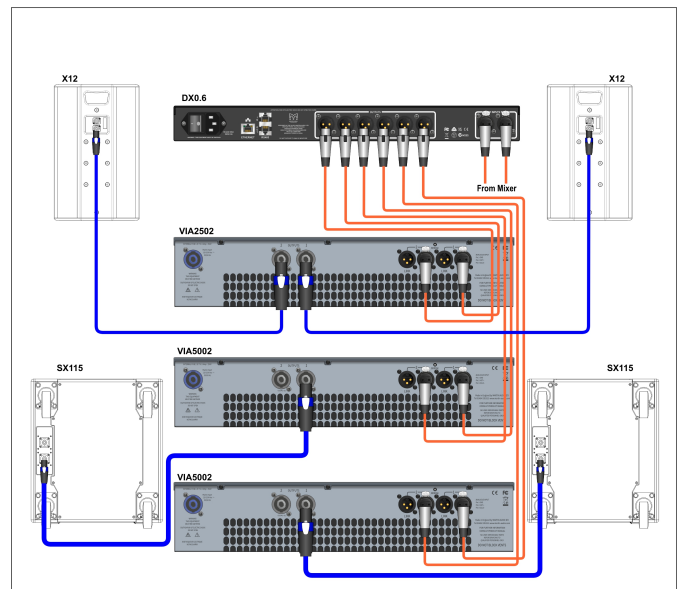

This is a portable system featuring BlacklineX12 full range speakers paired with SXC115 cardioid 15" subwoofers. This would be an ideal system for gigging bands or DJs in smaller clubs, bars and live music venues. It has the advantage of an incredibly compact subwoofer with output close to a twin 15" and the major advantage of cardioid dispersion ensuring minimal sub frequency spill

on stage. This would give a far better experience on stage for the musicians or DJ and eliminate problematic reflections off rear walls.

The SXC115 requires two channels of amplification, one channel for the front facing driver and one for the rear facing driver, both of which require independent processing. The system uses a DX0.6 to provide the processing required with channels 1 and 2 for the front and rear processing for the left sub, channels 3 and 4 for the right sub and channels 5 and 6 for the left and right X12 speakers.

The system uses three Martin Audio amplifiers:

- Two VIA5002 amplifiers, one for each of the SXC115 subs.
- One VIA2502 amplifier for the two X12 speakers.

Short XLR leads connect the DX0.6 to the amplifiers. Outputs 1 and 2 go to inputs 1 and 2 of the first VIA5002. Outputs 3 and 4 go to inputs 1 and 2 of the second VIA5002. Outputs 5 and 6 go to inputs 1 and 2 of the VIA2502.

The outputs from the VIA5002 amplifiers use a single 4-core NL4 speaker lead connected to output 1. This has channel 1 on pins 1+/- and channel 2 on pins 2+/- so that the two independent channels are fed to each subwoofer down a single cable. The outputs from the VIA2502 are standard NL4 speaker cables with output 1 to one X12 and output 2 to the other X12.

To configure the DX0.6 output channels, use the presets for the SXC115 front on channels 1 and 3, SXC115 rear on channels 2 and 4 and X12 on output channels 5 and 6. For fully stereo operation, route input A to outputs 1, 2 and 5 and input B to outputs 3, 4 and 6. You could configure the subwoofers in mono. In this case, route input channel A to outputs 1, 2, 3, 4 and 5 and input B to outputs 1, 2, 3, 4 and 6.

Troubleshooting

No power

- Make sure the power cord is securely seated in the IEC socket and plugged all the way into the AC outlet.
- Make sure the [back panel power switch \(page 9\)](#) is in the **On** position.
- Check the lights in your building or local area. There could be a power cut.
- Check that the AC outlet is live using a tester or lamp.
- Check the fuse in the power cable plug.
- If you have checked all of the above and there are still no lights on the front panel, contact our product support team. For details, see our website martin-audio.com.

Noise or hum

- Check the signal cables between the mixer and the processor and the processor, amps and loudspeakers. Disconnect them one-by-one. If the noise goes away, you will know which input or output is causing the problem.
- It often helps to plug all the audio equipment into the same AC circuit so that they share a common ground.

No sound

- Are the level controls on the mixer or amplifier turned all the way down? Follow the instructions in [Connecting your system \(page 7\)](#) and make sure that all the volume controls in the system are properly adjusted.
- Is the signal source working?
- Make sure that all connecting cables are in good condition with secure connections at both ends.

One side is louder than the other

- Are the level controls set the same for both sides on the mixer, amplifier and processor?
- Are the gain settings the same for all left-right pairs of inputs and outputs on the processor?
- Are the EQ settings the same for all left-right pairs of inputs and outputs on the processor?
- Are the limiter settings the same for all left-right pairs of outputs on the processor?

- Check the pan control on the signal source. It may be turned too far to one side. If you're using a stereo signal source, it may be delivering an out-of-balance stereo signal.
- Try switching sides as follows:
 1. Turn off the amp.
 2. Swap the speaker cables at the amp.
 3. Turn the amp back on.

If the same side is still louder, the problem is with your speaker cabling or the loudspeakers.

If the loudness has switched sides, the problem is with the mixer, the amp or the line-level cabling.

Bad sound

- Check the input and output connectors to make sure that you have plugged them completely into the sockets.
- If the sound is loud and distorted, reduce the signal level at the mixer, amplifier and/or processor.
- If possible, listen to the signal source with headphones plugged into the preamp stage. If this sounds bad, you know it's not the fault of the processor.
- Are your gain and EQ settings too high? You should only need modest amounts of cut and boost. If you need extreme amounts of cut and boost, there is something wrong elsewhere.

Can't change settings

- If the front panel displays the message **System Locked**, you can't use the front panel. You can't even use the mute buttons. Note that you can't unlock the front panel at the processor, even if you are an [Admin or Expert user \(page 20\)](#). The only way to control or unlock the processor is by using the [desktop app \(page 6\)](#). For details, see **System locks** in the [desktop app user guide \(page 6\)](#).
- If there are settings that you can't update, this could be because you don't have access rights to these settings. For details, see **User settings** in the [desktop app user guide \(page 6\)](#).
- If there are channel presets that you can't update, these are probably locked presets. For details,

see **Channel presets** in the [desktop app user guide \(page 6\)](#).

Technical specifications

General	
Input impedance	20k Ohm balanced
Output Imp	100R
Max input level	+20dBu
Max output level	+18dBu
Crosstalk	< -95dB
Sample rate	96kHz
Signal to noise ratio	> 113dB (A weighted)
Noise floor	< -94dB (A weighted)
Common Mode Rejection Ratio	60dB
Frequency response	20Hz to 40kHz +0.3dB
Input A/D dynamic range	118dB
Output D/A dynamic range	118dB
THD (+4dBu 1kHz)	< 0.003%
Mains voltage range	85-230VAC 50-60Hz
Nominal power consumption	30W

Connectors	
Audio input	2 x 3 pin female XLR
Audio output	6 x 3 pin male XLR
Ethernet	Shielded RJ45, dynamic or static IP
RS485	2 x RG45
USB	1 x USB B (front panel)
Mains	3 pin IEC

Processing	
Signal Generator	White or pink noise, -30dBu to +10dBu
Gain	-18dB to +12dB, step accuracy 0.1dB
Input equaliser	10 band PEQ, gain range +15dB 14 x Filter types
Input gate	Threshold: -40 to -80dBu Attack: 1 to 1,000ms Release: 1 to 1,000ms
Routing	Freely assignable 2-in, 6-out Up to 30dB attenuation on each node
Delay	Input: 0 to 600ms Output: 0 to 200ms Steps: 20us Units: milliseconds, metres, feet

Processing	
Output filters	High & Low Pass, -6dB/Octave to -48dB/Octave Slope types: Butterworth, Bessel, Linkwitz-Riley
Output equalisation	8 band PEQ, gain +15dB 14 x filter types FIR Filter Import
Program limiter	Threshold: -10 to +20dBu Attack: 1 to 1,000ms Release: 10 to 3,000ms
Peak limiter	Threshold: 0 to 12dB above Program Limiter Threshold (max +20dBu) Release: Fast (91ms), Medium (350ms), Slow (800ms)

Dimensions	
Height	1U (44mm) [1.75"]
Width	482mm [19"]
Depth	230mm [9.1"]
Weight	3.0kg [6.6lb]

Martin Audio Limited

Century Point

Halifax Road

Cressex Business Park

High Wycombe

Buckinghamshire

HP12 3SL

England

FOR SALES ENQUIRIES

UK

+44 1494 535 312

info@martin-audio.com

NORTH AMERICA

+1 323 381 5310

www.martin-audio.com

Martin Audio, the Martin Audio logo and Hybrid are registered trademarks of Martin Audio Ltd. in the United Kingdom, United States and other countries; all other Martin Audio trademarks are the property of Martin Audio Ltd.

